

Armadi spogliatoio

**VALPREDA Srl**

[www.valpreda.it](http://www.valpreda.it)

**IMBALLAGGIO LOGISTICA E MOVIMENTAZIONE**



### Dettagli tecnici:

- Tetto inclinato,
- Antine dotate di feritoie per aerazione interna
- Portacartellino di serie
- Standard: chiusura con blocchetto per lucchetto
- Ripiano superiore formante uno spazio adeguato per riporre il casco motociclistico
- Tramezza di separazione per indumenti puliti e da lavoro, secondo le attuali norme vigenti
- Tubo appendigrucce in metallo ricoperto in materiale plastico con ganci
- Vano inferiore portascarpe
- Cerniere interne invisibili antiscasso
- Verniciatura a polveri di epossipoliestere nei colori di serie
- Interamente costruito in lamiera 8/10



① Asole di areazione

② Portacartellino di serie

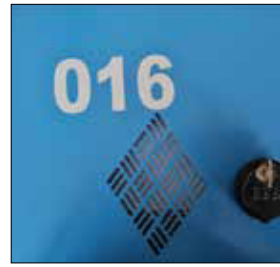

○ Opzionale: numerazione ante



③ Tubo appendigrucce con gancio in plastica



④ Chiusura a scelta con blocchetto per lucchetto o serratura. Disponibile a richiesta anche con chiusura a serratura a combinazione meccanica, elettronica e a moneta.  
Opzionale: chiave passpartout



⑤ Divisore per vestiti sporchi e puliti

⑥ Ripiano inferiore poggiascarpe



⑦ Piedini in metallo  
Opzionale: guaina in gomma antiossidazione



⑧ Tetto inclinato

**COLORE STRUTTURA**



**ANTE DI DIVERSE COLORAZIONI**





Spogliatoi

109/10SIB



109/10SIB

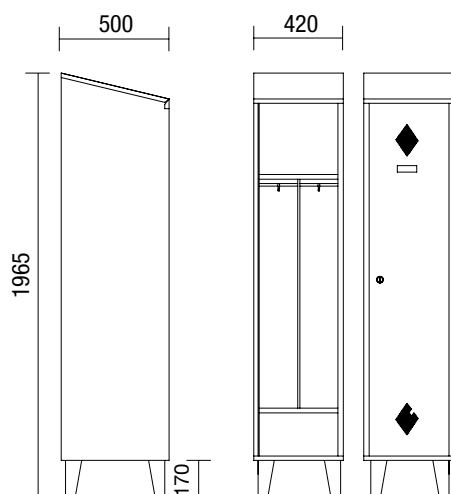

109/10SGIB

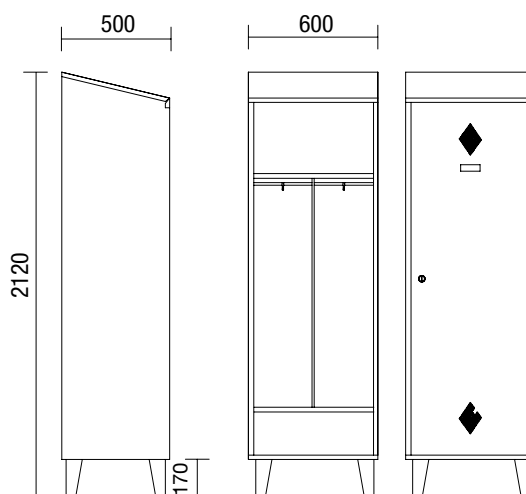

**109/10IB**

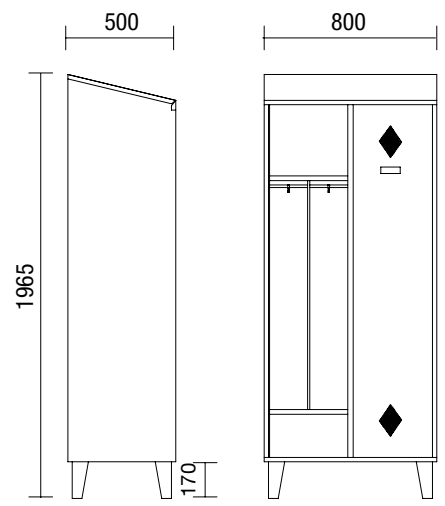

**109/10Z**

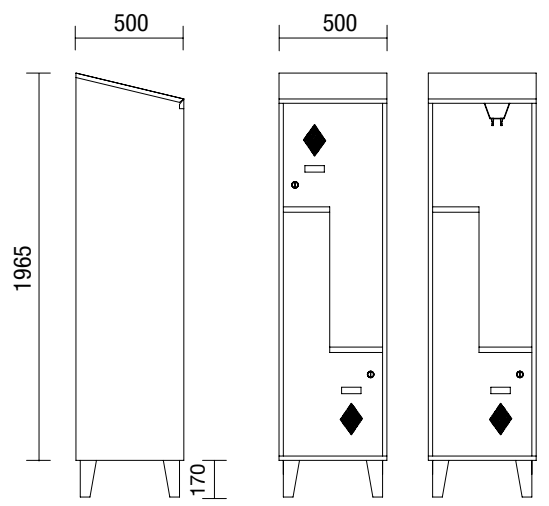



Spogliatoi

**Serie 109/11**



Panca con gambe e telaio a supporto del corpo dello spogliatoio realizzata in tubolare quadro mm 40x40.  
Doghe in metallo in tubolare ovale o in legno faggio.

**FORNITO STANDARD CON TETTO INCLINATO.**

109/11/2

109/11/4

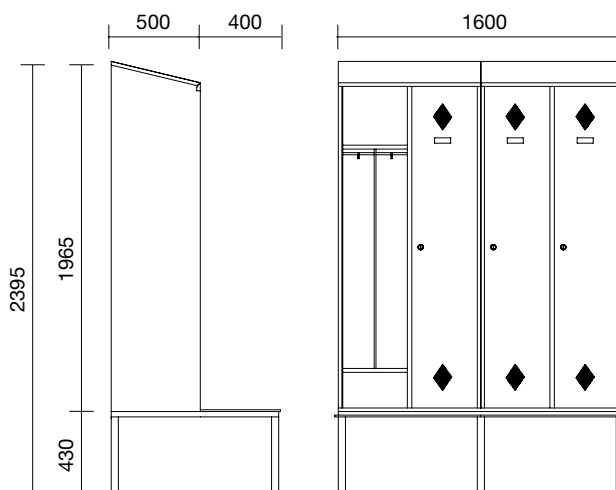
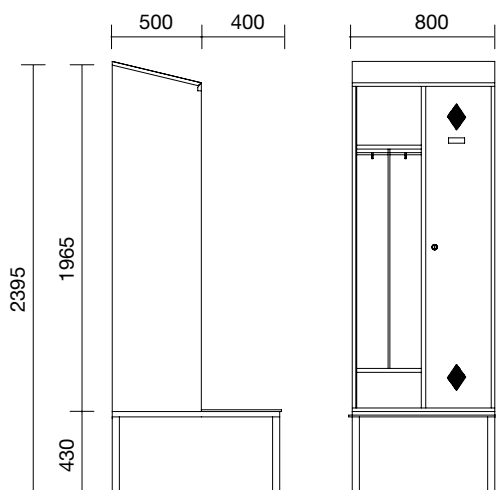



**COLORE STRUTTURA**



**ANTE DI DIVERSE COLORAZIONI**





Spogliatoi

109/10D



*Disponibili nelle versioni:*

1. vano completamente vuoto
2. vano con appendiabiti e gancio
3. vano con divisorio sporco pulito, ripiano inferiore e appendiabito con un gancio per ogni scomparto

**Modello 1+1 posti sovrapposti**

109/10D2

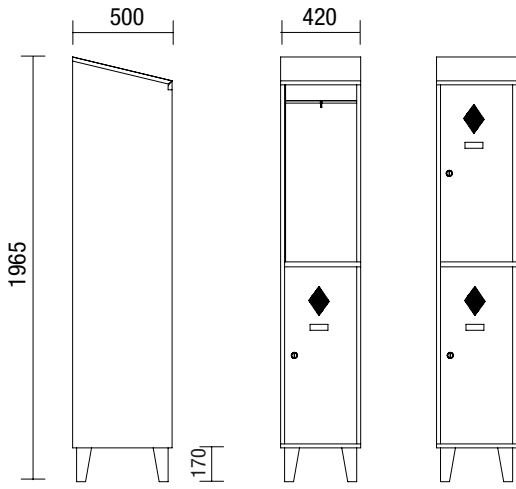

109/10D2T

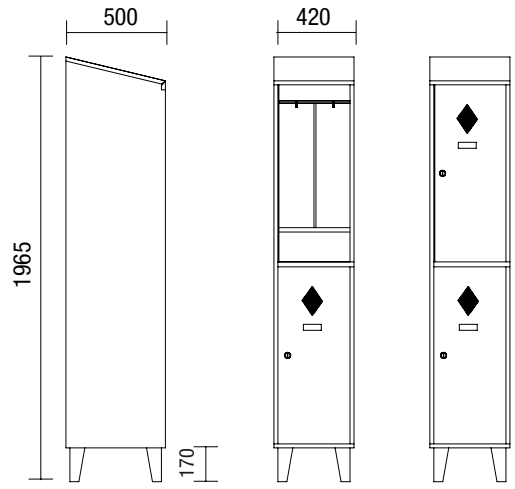

**Modello 2+2 posti sovrapposti**

109/10D4

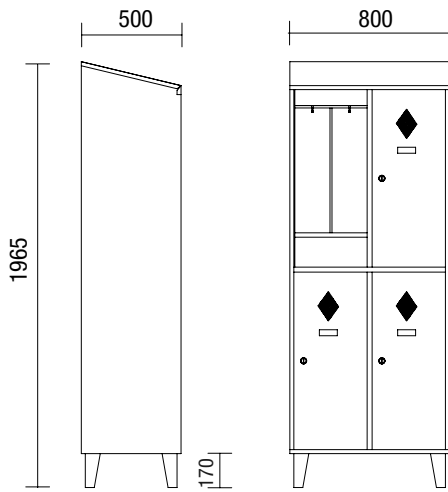

109/10D4T

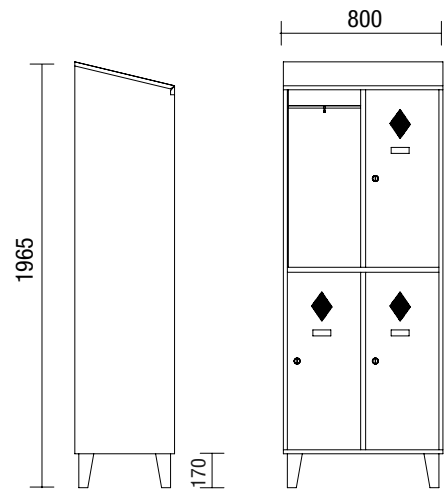

**Modello 3+3 posti sovrapposti**

109/10D6

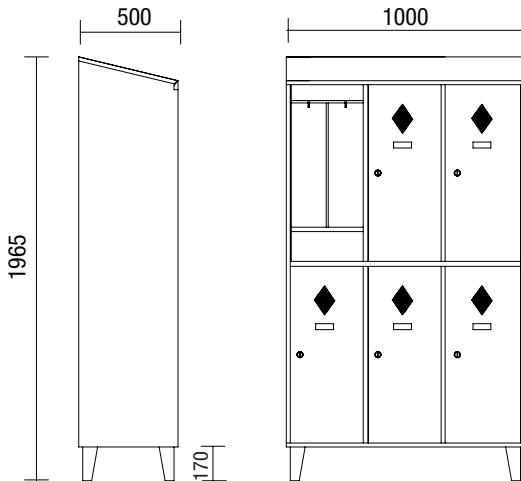

109/10D6T

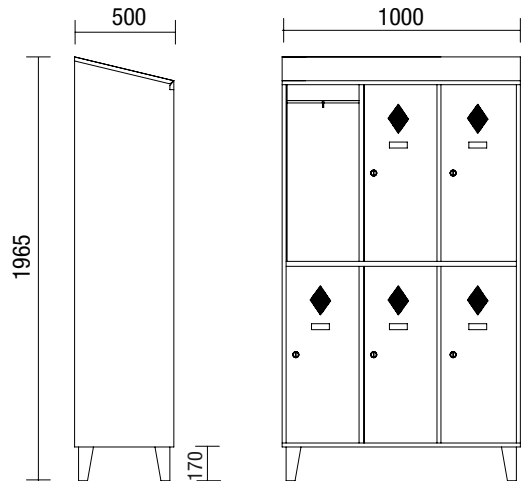



Spogliatoi

109/B



### Dettagli tecnici:

- Spogliatoio a 3 ante con la possibilità di inserire in ciascun vano 1 o 2 appendiabiti.
- Realizzato in lamiera 8/10 con piedini a L con piedino in gomma.
- Verniciatura a forno con polveri di eposipoliestere. Colori da definire in base ai quantitativi.
- Ante con maniglie in materiale plastico

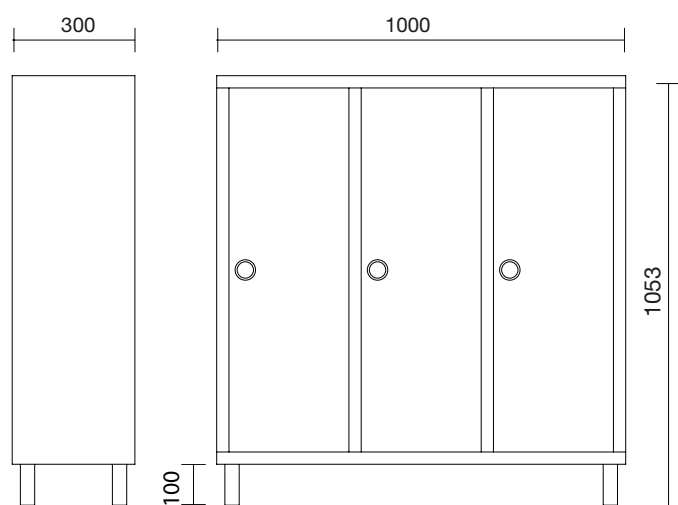

### Tabella riassuntiva codici e specifiche armadi

Cod.	Misure			Posti	Descrizione
	L	P	H		
109/10S IB	42	50	196,5	1	A norme ASL, con divisorio sporco pulito, piano superiore e inferiore poggiascarpe.
109/10SG	60	50	212	1	A norme ASL per indumenti ingombranti, con divisorio sporco pulito, piano superiore e inferiore poggiascarpe.
109/10/D6	100	50	196,5	6	Armadio a 6 posti (3+3) sovrapposti senza divisori interni
109/10/D6T	100	50	196,5	6	Armadio a 6 posti (3+3) sovrapposti con divisorio sporco pulito e piano inferiore poggiascarpe
109/10/D4	80	50	196,5	4	Armadio a 4 posti (2+2) sovrapposti senza divisori interni
109/10/D4T	80	50	196,5	4	Armadio a 4 posti (2+2) sovrapposti con divisorio sporco pulito e piano inferiore poggiascarpe
109/10/D2	42	50	196,5	2	Armadio a 2 posti (1+1) sovrapposti senza divisori interni
109/10/D2T	42	50	196,5	2	Armadio a 2 posti (1+1) sovrapposti con divisorio sporco pulito e piano inferiore poggiascarpe
109/10/DT	80	50	197/213	4	Armadio a 4 posti (2+2) sovrapposti con divisorio sporco-pulito e piano inferiore poggiascarpe
109/10/DST	42	50	197/213	2	Armadio a 2 posti (1+1) sovrapposti con divisorio sporco-pulito e piano inferiore poggiascarpe
109/10 IB	80	50	196,5	2	A norme ASL, con divisorio sporco e pulito, piano superiore e inferiore poggiascarpe.
109/10Z	50	50	196,5	2	Spogliatoio a 2 posti con ante a Z
109/11/4	160	50	239,5	4	A norme ASL su panca, con divisorio sporco e pulito, piano superiore e inferiore poggiascarpe.
109/11/2	80	50	239,5	2	A norme ASL su panca, con divisorio sporco e pulito, piano superiore e inferiore poggiascarpe.
109/10/TR					Tramezza per un posto
109/B	100	30	105		Spogliatoio a 3/6 posti per scuola infanzia
S/PG					Piedini in gomma
S/S					Specchio
S/BZ2					Base a zoccolo a 2 posti
S/BZ1					Base a zoccolo a 1 posto



# Armadi spogliatoio

Serie 109\_ZNP



LOCKER  
NO. 001  
KEY NO. 1234  
DO NOT REMOVE  
THIS LABEL

LOCKER  
NO. 002  
KEY NO. 5678  
DO NOT REMOVE  
THIS LABEL

LOCKER  
NO. 003  
KEY NO. 9012  
DO NOT REMOVE  
THIS LABEL

LOCKER  
NO. 004  
KEY NO. 3456  
DO NOT REMOVE  
THIS LABEL

LOCKER  
NO. 004  
KEY NO. 3456  
DO NOT REMOVE  
THIS LABEL

005

006

LOCKER  
NO. 005  
KEY NO. 7890  
DO NOT REMOVE  
THIS LABEL

LOCKER  
NO. 006  
KEY NO. 1234  
DO NOT REMOVE  
THIS LABEL



Spogliatoi

## SERIE 109ZNP



### *Dettagli tecnici:*

- Armadi spogliatoio a norme Asl a 1, 2, 3 posti con struttura e divisori interni in lamiera zincata spessore 6/10
- Tetto inclinato e base a zoccolo ricavato dai fianchi con piedini in gomma
- Ante in lamiera spessore 8/10 verniciata a forno con polveri di epossipoliestere. Colori a scelta tra grigio, verde, rosso, blu. Dotate di feritoie per area-zione interna e di cartellino
- Chiusura con maniglia metallica lucchettabile o serratura
- Ripiano superiore
- Tubo appendigrucce e ganci
- Divisorio verticale sporco-pulito



- ① Asole di areazione
- ② Portacartellino di serie



- ③ Tubo appendigrucce con gancio in plastica



- ⑤ Divisore per vestiti sporchi e puliti



- ⑦ Tetto inclinato

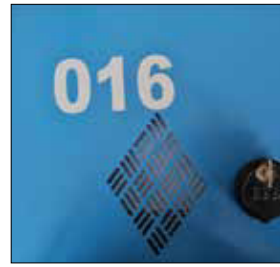

- Opzionale: numerazione ante



- ④ Chiusura a scelta con lucchetto o serratura. Disponibile a richiesta anche con chiusura a serratura a combinazione meccanica, elettronica e a moneta. Opzionale: chiave passpartout



- ⑥ Zoccolino ricavato dai fianchi

#### COLORE STRUTTURA



#### ANTE DI DIVERSE COLORAZIONI





Spogliatoi

109\_ZNP\_1

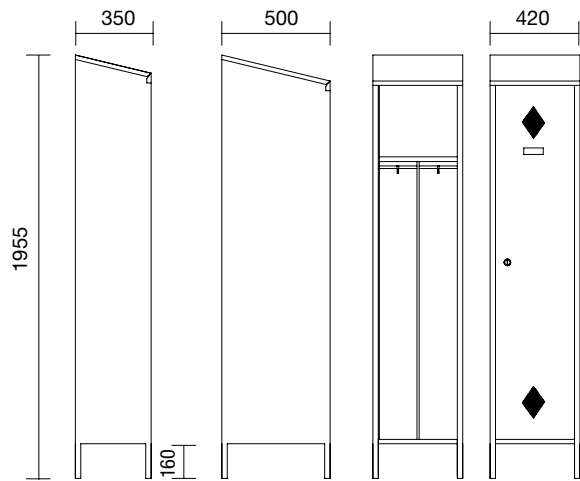

109\_ZNP\_2

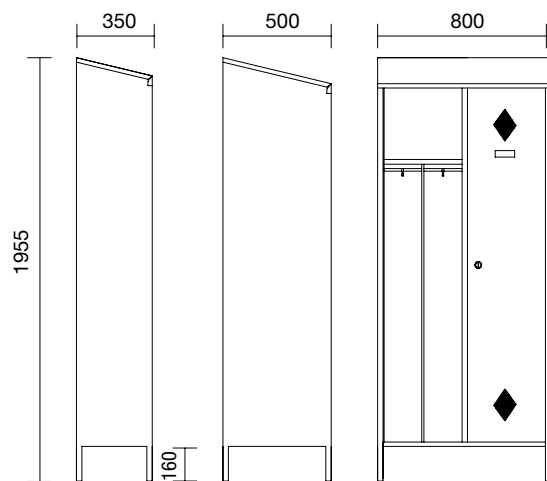

109\_ZNP\_3

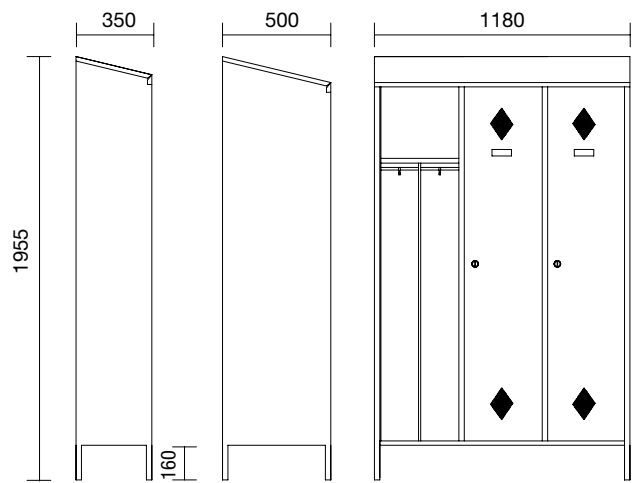

Cod.	Misure			Posti
	L	P	H	
109_ZNP_1	42	50	180/196	1
109_ZNP_2	80	50	180/196	2
109_ZNP_3	118	50	180/196	3
109_ZNP35_1	42	35	180/196	1
109_ZNP35_2	80	35	180/196	2
109_ZNP35_3	118	35	180/196	3
109_ZNP_4D	80	50	180/196	4
P-ZNP	Pianetto per vano porta scarpe per mod. 109_ZNP			



Panche





Panche

SERIE PANCHE123



### Dettagli tecnici panche alte doghe metallo

- Struttura metallica in tubo diam 50 mm
- Doghe in tubo ovale mm 40x20 con tappi di chiusura in gomma
- Piano superiore e inferiore in rete
- Supporto per schiena e appendiabiti in lamiera sagomata
- Pomoli appendiabiti in materiale plastico
- Gambe con guaina in gomma mm 100 H
- Verniciatura parti metalliche a polveri epossidiche

**FINITURE DISPONIBILI**



Cod.	Misure			Descrizione
	L	P	H	
123/100	100	42	180	Panca con appendiabiti e cappelliera con 4 appendini
123/150	150	42	180	Panca con appendiabiti e cappelliera con 5 appendini

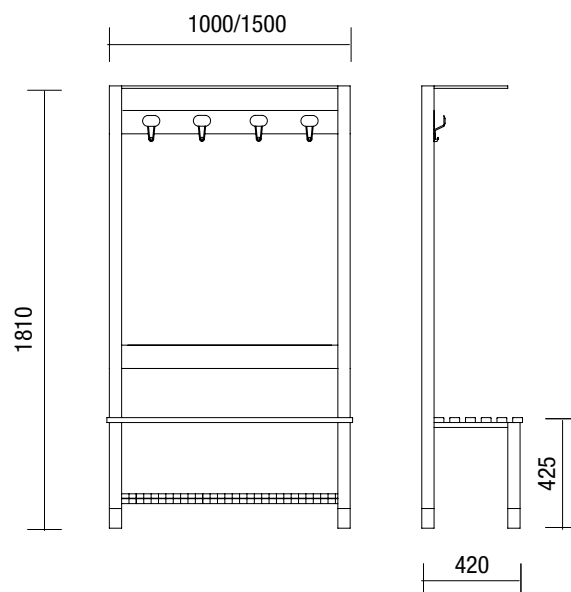



Panche

## PANCHE BASSE DOGHE METALLO



### Dettagli tecnici

- Gambe metalliche in tubo diam 50 mm
- Doghe in tubo ovale mm 40x20 con tappi di chiusura in gomma
- Gambe con guaina in gomma mm 100 H

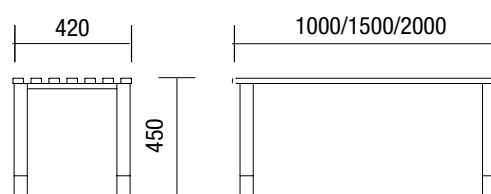

Cod.	Misure			Descrizione
	L	P	H	
123B/100	100	42	45	Panca con gambe in tubolare tondo
123B/150	150	42	45	Panca con gambe in tubolare tondo
123B/200	200	42	45	Panca con gambe in tubolare tondo

### FINITURE DISPONIBILI





### Dettagli tecnici

- Struttura metallica in tubo quadro diam 40x40 mm
- Doghe in tubo ovale mm 40x20 con tappi di chiusura in gomma
- Gambe con piedini in materiale plastico

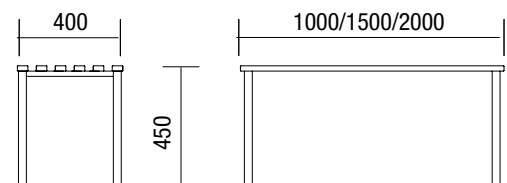

Cod.	Misure			Descrizione
	L	P	H	
123B/100Q	100	40	45	Panca con gambe in tubolare quadro
123B/150Q	150	40	45	Panca con gambe in tubolare quadro
123B/200Q	200	40	45	Panca con gambe in tubolare quadro

#### FINITURE DISPONIBILI





Panche

## PANCHE ALTE DOGHE LEGNO



### *Dettagli tecnici*

- Struttura portante in tubo d'acciaio mm 30x30x2
- Gambe con piedini in materiale plastico
- Seduta realizzata con 3 doghe in legno faggio, bordi smussati, verniciate al naturale dimensioni mm 95x20
- Seduta, cappelliera e supporto schiena in legno faggio verniciato al naturale, doghe mm 95x20
- Pomoli appendiabiti in materiale plastico
- Verniciatura parti metalliche a polveri epossidiche



**ALTRI TIPI DI SEDUTA:**

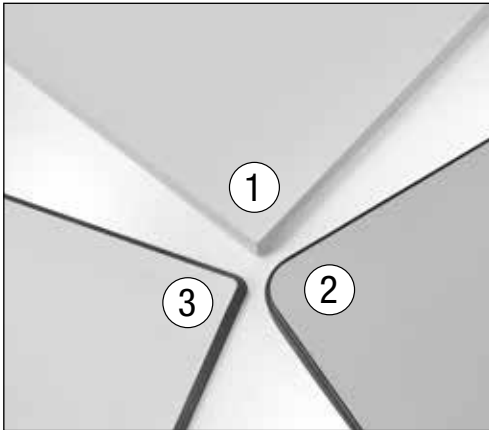

1. Piano in melaminico bordato ABS
2. Piano in legno melaminico con bordi arrotondati in gomma
3. Piano in HPL

Colori disponibili: bianco, grigio chiaro e antracite  
Chiedi le finiture legno disponibili

Disponibili anche in FENIX

**FINITURE DISPONIBILI**



Cod.	Misure			Descrizione
	L	P	H	
123/100L	100	39	168	Panca 4 appendini
123/150L	150	39	168	Panca 5 appendini
123/200L	200	39	168	Panca 6 appendini
123/100LC	100	39	183,5	Panca con cappelliera con 4 appendini
123/150LC	150	39	183,5	Panca con cappelliera con 4 appendini
123/200LC	200	39	183,5	Panca con cappelliera con 6 appendini

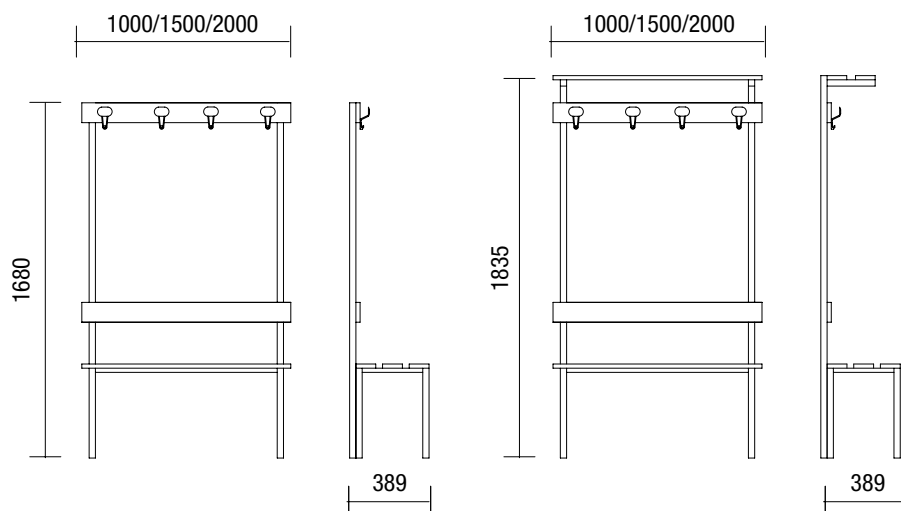



Panche

**PANCHE BASSE DOGHE LEGNO**

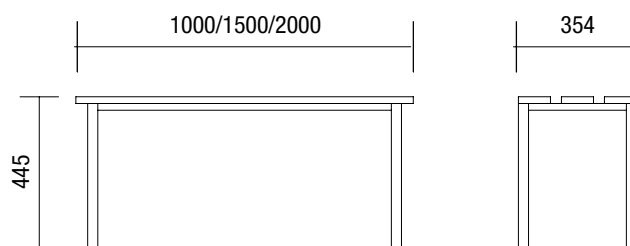

### FINITURE DISPONIBILI



Seduta standard realizzata con tre doghe in legno massello faggio con bordi smussate, verniciate al naturale.

Dimensioni: mm 95x20

### Dettagli tecnici

- Struttura portante in tubo d'acciaio mm 30x30x2
- Gambe con piedini in materiale plastico
- Seduta realizzata con 3 doghe in legno faggio, bordi smussati, verniciate al naturale dimensioni mm 95 x 20
- Verniciatura delle parti metalliche a polveri di eposipoliestere

### ALTRI TIPI DI SEDUTA:

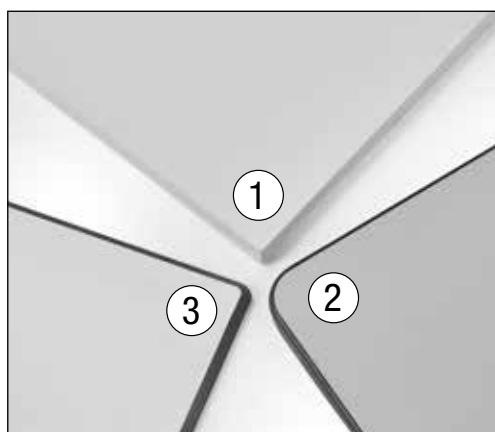

1. Piano in legno melaminico bordato ABS
2. Piano in legno melaminico con bordi arrotondati in gomma
3. Piano in HPL

Colori disponibili: bianco, grigio chiaro e antracite  
Chiedi le finiture legno disponibili

Disponibili anche in FENIX

Cod.	Misure			Descrizione
	L	P	H	
123B/100L	100	35	44,5	Panca con doghe legno faggio
123B/150L	150	35	44,5	Panca con doghe legno faggio
123B/200L	200	35	44,5	Panca con doghe legno faggio
123B/100M	100	35	44,5	Panca con piano melaminico
123B/150M	150	35	44,5	Panca con piano melaminico
123B/200M	200	35	44,5	Panca con piano melaminico
123B/100G	100	35	44,5	Panca con piano melaminico bordato gomma
123B/150G	150	35	44,5	Panca con piano melaminico bordato gomma
123B/200G	200	35	44,5	Panca con piano melaminico bordato gomma
123B/100H	100	35	44,5	Panca con piano in HPL
123B/150H	150	35	44,5	Panca con piano in HPL
123B/200H	200	35	44,5	Panca con piano in HPL

START

PRO

PRO+

# ARMADI SPOGLIATOIO

## PERFOM



Realizzati in robusta lamiera d'acciaio, gli armadi spogliatoio facilitano la custodia di indumenti e abiti di lavoro. Ogni scomparto ha una **profondità di 500 mm** ed è chiuso da una porta con feritoie per la circolazione dell'aria e **serratura a cilindro con chiave**. La configurazione con **divisorio sporco/pulito** e **tetto inclinato** li rende adatti ad essere impiegati negli ambienti che richiedono un elevato grado di pulizia e che devono rispondere alla normativa HACCP. Gli armadi spogliatoio possono essere ulteriormente arricchiti con  **piedini in polipropilene** resistenti all'acqua e **panche** singole di varie dimensioni.

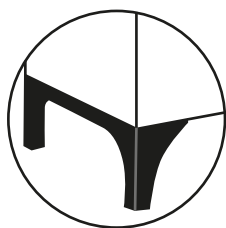

**PIEDINI IN  
POLIPROPILENE  
FACILE PULIZIA**

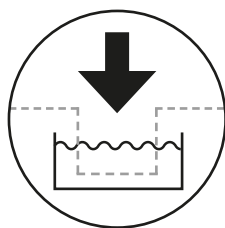

**VERNICIATURA IN  
ELETTROFORESI**



**VERSIONE CON VANO  
PORTA CASCO**

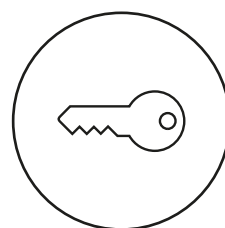

**CHIUSURA A CHIAVE**



ART.	L mm	P mm	H mm	n. scomparti	RAL	€
<b>PERFOMAN01</b>	1195	502	1950	4	7035	478,20

Composto da:

qtà	descrizione
1	Armadio spogliatoio a tetto orizzontale a 4 scomparti
1	Coppia piedini per armadio spogliatoio



ART.	L mm	P mm	H mm	n. scomparti	RAL	€
<b>PERFOMAN02</b>	1195	502	1950	3	7035	478,20

Composto da:

qtà	descrizione
1	Armadio spogliatoio a tetto orizzontale a 3 scomparti
1	Coppia piedini per armadio spogliatoio



ART.	L mm	P mm	H mm	n. scomparti	RAL	€
<b>PERFOMAN03</b>	1195	502	2170	4	7035	549,90

Composto da:

qtà	descrizione
1	Armadio spogliatoio a tetto orizzontale a 4 scomparti
1	Tetto inclinato aggiuntivo
1	Coppia piedini per armadio spogliatoio

# PERFOM



ART.	Lmm	Pmm	Hmm	n. scomparti	RAL	€
<b>PERFOMAN04</b>	1195	502	2170	3	7035	549,90

Composto da:

qtà	descrizione
1	Armadio spogliatoio a tetto orizzontale a 3 scomparti
1	Tetto inclinato aggiuntivo
1	Coppia piedini per armadio spogliatoio

## PANCHINA SINGOLA



ART.	Lmm	Pmm	Hmm		RAL	€
<b>FAN95400001</b>	1000	360	385/400	200	7000	103,80



ART.	Lmm	Pmm	Hmm		RAL	€
<b>FAN95500001</b>	1494	360	385/400	200	7000	125,40



ART.	Lmm	Pmm	Hmm		RAL	€
<b>FAN95600001</b>	2000	360	385/400	300	7000	177,30



ART.	L mm	P mm	H mm	n. scomparti	RAL	€
FAN1302C00108	608	502	1750	2	7035	280,20

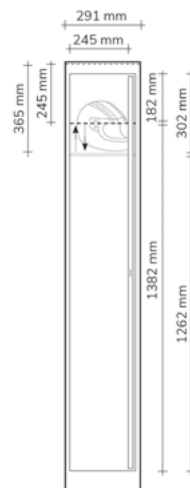

### TETTO INCLINATO AGGIUNTIVO



ART.	L mm	P mm	H mm	RAL	€
FAN51400008	607	502	220	7035	49,50



ART.	L mm	P mm	H mm	n. scomparti	RAL	€
FAN1303C00108	900	502	1750	3	7035	359,70

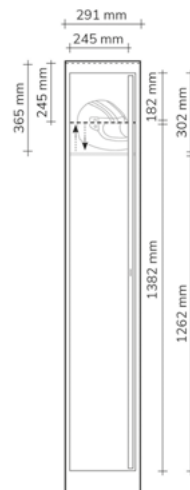

### TETTO INCLINATO AGGIUNTIVO



ART.	L mm	P mm	H mm	RAL	€
FAN51600008	899	502	220	7035	62,10



PORTATA



RAL 7000



RAL 7035



ART.	L mm	P mm	H mm	n. scomparti	RAL	€
FAN1304C00108	1192	502	1750	4	7035	464,70

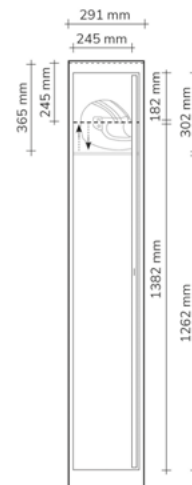

#### TETTO INCLINATO AGGIUNTIVO

ART.	L mm	P mm	H mm	RAL	€
FAN51800008	1191	502	220	7035	71,70



#### COPPIA PIEDINI PER ARMADIO SPOGLIATOIO

ART.	L mm	P mm	H mm	colore	€
FRR23100001	135	500	180/200	Grigio scuro	13,50



ART.	L mm	P mm	H mm	n. scomparti	RAL	€
<b>FAN1502C03108</b>	802	502	1750	2	7035	340,80

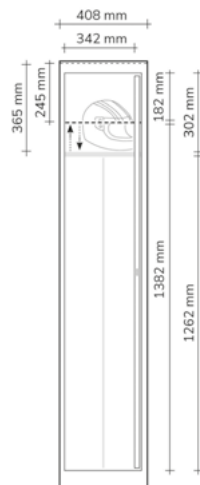

### TETTO INCLINATO AGGIUNTIVO

ART.	L mm	P mm	H mm	RAL	€
<b>FAN51500008</b>	801	502	220	7035	54,30



ART.	L mm	P mm	H mm	n. scomparti	RAL	€
<b>FAN1503C03108</b>	1192	502	1750	3	7035	464,70

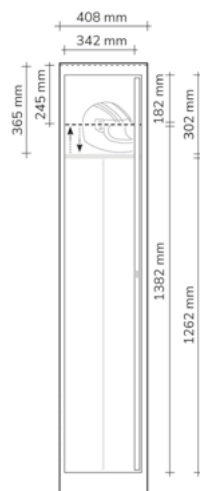

### TETTO INCLINATO AGGIUNTIVO

ART.	L mm	P mm	H mm	RAL	€
<b>FAN51800008</b>	1191	502	220	7035	71,70



ELENCO  
ACCESSORI

Nasello in metallo pag. 13

NOTE  
TECNICHE

- **STRUTTURA MONOBLOCCO.**
- **VERNICIATURA A POLVERE.**

COLORE  
DI SERIE

  
RAL 7038

VARIANTE  
COLORE

  
RAL 7038 scocche  
RAL 5015 ante  
CONSEGNA 30 GG.

Realizzati in lamiera di acciaio di prima scelta spessore 6-7/10. Ogni posto di profondità mm. 330 è corredato di 1 cappelliera, 1 appendiabiti in plastica e 1 gancio per asciugamani; ogni posto di profondità mm. 500 è corredato di 1 cappelliera, 1 tubo portagruccie e 2 ganci per asciugamani. Le ante sono rinforzate, dotate di foratura per l'aerazione e chiusura con serratura a linguetta. L'altezza dei piedi è di mm. 190, protetti con puntali in plastica.



**PROFONDITÀ 330 mm.**

Vano cappelliera mm. 255 x 285 x 165 h. utile.



ARMADIO  
art. **E504**

ACCESSORIO  
TETTO ANTIPOLVERE  
art. **E409**

ARMADIO  
art. **E506**

ACCESSORIO  
TETTO ANTIPOLVERE  
art. **E418**

ARMADIO  
art. **E500**

ACCESSORIO  
TETTO ANTIPOLVERE  
art. **E383**

ARMADIO  
art. **E502**

ACCESSORIO  
TETTO ANTIPOLVERE  
art. **E384**



TETTO ANTIPOLVERE  
vedi pag. 13

ART.	DIMENSIONI LxPxH (mm)	VANI
<b>E500</b>	315 x 330 x 1800	1
<b>E502</b>	610 x 330 x 1800	2
<b>E504</b>	905 x 330 x 1800	3
<b>E506</b>	1200 x 330 x 1800	4

ELENCO  
ACCESSORI

Nasello in metallo pag. 13  
Grucce pag. 13

NOTE  
TECNICHE

- **STRUTTURA MONOBLOCCO.**
- **VERNICIATURA A POLVERE.**

COLORE  
DI SERIE



VARIANTE  
COLORE



**PROFONDITÀ 500 mm.**

Vano cappelliera mm. 255 x 390 x 165 h. utile.



ARMADIO  
art. **E512**

ACCESSORIO  
TETTO  
ANTIPOLVERE  
art. **E419**



ARMADIO  
art. **E514**

ACCESSORIO  
TETTO  
ANTIPOLVERE  
art. **E420**



ARMADIO  
art. **E516**

ACCESSORIO  
TETTO  
ANTIPOLVERE  
art. **E387**



**PROFONDITÀ 500 mm.**

Vano interno mm. 245 x 480 x 745 h. utile.



ARMADIO  
art. **E542**

ACCESSORIO  
TETTO  
ANTIPOLVERE  
art. **E419**



ARMADIO  
art. **E544**

ACCESSORIO  
TETTO  
ANTIPOLVERE  
art. **E420**



ARMADIO  
art. **E546**

ACCESSORIO  
TETTO  
ANTIPOLVERE  
art. **E387**

ART.	DIMENSIONI LxPxH (mm)	VANI
<b>E512</b>	610 x 500 x 1800	2
<b>E514</b>	905 x 500 x 1800	3
<b>E516</b>	1200 x 500 x 1800	4
<b>E542</b>	610 x 500 x 1800	4
<b>E544</b>	905 x 500 x 1800	6
<b>E546</b>	1200 x 500 x 1800	8



TETTO ANTIPOLVERE  
vedi pag. 13

ELENCO  
ACCESSORI

Nasello in metallo pag. 13  
Gruccia pag. 13

NOTE  
TECNICHE

- STRUTTURA MONOBLOCCO.
- VERNICIATURA A POLVERE.
- TRAMEZZA ZINCATA.

COLORE  
DI SERIE



VARIANTE  
COLORE

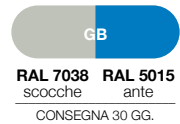

**PROFONDITÀ 500 mm.**

Vano cappelliera mm. 345 x 390 x 165 h. utile.  
Con tramezza.



ARMADIO  
art. **E520**

ACCESSORIO  
TETTO  
ANTIPOLVERE  
art. **E385**



ARMADIO  
art. **E522**

ACCESSORIO  
TETTO  
ANTIPOLVERE  
art. **E386**



ARMADIO  
art. **E524**

ACCESSORIO  
TETTO  
ANTIPOLVERE  
art. **E387**



**PROFONDITÀ 500 MM.**

Vano cappelliera mm. 345 x 390 x 165 h. utile.  
Vano portascarpe mm. 240 h. utile.  
Con tramezza.



ARMADIO  
art. **E526**

ACCESSORIO  
TETTO  
ANTIPOLVERE  
art. **E385**



ARMADIO  
art. **E528**

ACCESSORIO  
TETTO  
ANTIPOLVERE  
art. **E386**



ARMADIO  
art. **E530**

ACCESSORIO  
TETTO  
ANTIPOLVERE  
art. **E387**

ART.	DIMENSIONI LxPxH (mm)	VANI
<b>E520</b>	415 x 500 x 1800	1+1
<b>E522</b>	810 x 500 x 1800	2+2
<b>E524</b>	1200 x 500 x 1800	3+3
<b>E526</b>	415 x 500 x 1800	1+1
<b>E528</b>	810 x 500 x 1800	2+2
<b>E530</b>	1200 x 500 x 1800	3+3



TETTO ANTIPOLVERE  
vedi pag. 13

ELENCO  
ACCESSORI

Nasello in metallo pag. 13  
Grucce pag. 13

NOTE  
TECNICHE

- **STRUTTURA MONOBLOCCO.**
- **VERNICIATURA A POLVERE.**
- **PIEDI IN PLASTICA E ZOCCOLO DA MONTARE.**

COLORE  
DI SERIE

  
RAL 7038

VARIANTE  
COLORE

  
RAL 7038 RAL 5015  
scocche ante  
CONSEGNA 30 GG.

Dotati di cappelliera, piedi in plastica ad altezza regolabile e zoccolo in estruso termoplastico, rivestito in lamina di alluminio satinato e guarnizione alla base, per bloccare il passaggio di liquidi e sporco all'interno. Altezza zoccolo mm. 100.



**NEW**

ARMADIO  
art. **E562**

ACCESSORIO  
TETTO  
ANTIPOLVERE  
art. **E419**



**NEW**

ARMADIO  
art. **E564**

ACCESSORIO  
TETTO  
ANTIPOLVERE  
art. **E420**

ART.	DIMENSIONI LxPxH (mm)	VANI
<b>E562</b>	610 x 500 x 1700	2
<b>E564</b>	905 x 500 x 1700	3



Ideale per una persona, è corredato di tramezza verniciata per separazione sporco/pulito. Ogni vano è dotato di cappelliera e tubo appendiabiti per l'inserimento delle grucce. La doppia anta permette di contenere l'ingombro di apertura delle stesse e di separare i due vani in modo più accurato.

ARMADIO  
art. **E550**

DIMENSIONI LxPxH (mm)  
**610 x 500 x 1800**

VANI  
**1+1**

ACCESSORIO  
TETTO ANTIPOLVERE  
art. **E419**



TETTO ANTIPOLVERE  
vedi pag. 13

**ELENCO ACCESSORI**

Lucchetto pag. 13  
Serratura pag. 13

**NOTE TECNICHE**

- **STRUTTURA MONOBLOCCO.**
- **VERNICIATURA A POLVERE.**

**COLORE DI SERIE**

  
**RAL 7038**

**VARIANTE COLORE**

  
**RAL 7038** **RAL 5015**  
scocche ante  
CONSEGNA 30 GG.

Realizzati in lamiera di acciaio di prima scelta spessore 6-7/10. Ogni posto di profondità mm. 330 è corredato di 1 cappelliera, 1 appendiabiti in lamiera, 1 gancio per asciugamani e 1 anello con vaschetta portaombrelli; ogni posto di profondità mm. 500 è corredato di 1 cappelliera, 1 tubo portagruccie, 2 ganci per asciugamani e 1 anello con vaschetta portaombrelli. Le ante sono rinforzate, dotate di feritoie d'aerazione, portacartellino e chiusura con nasello in plastica lucchettabile. L'altezza dei piedi è di mm. 190, protetti con puntali di plastica.



**PROFONDITÀ 330 mm.**

Vano cappelliera mm. 270 x 280 x 165 h. utile.

ARMADIO  
art. **E336**

ACCESSORIO  
TETTO ANTIPOLVERE  
art. **E396**



ARMADIO  
art. **E334**

ACCESSORIO  
TETTO ANTIPOLVERE  
art. **E394**



ARMADIO  
art. **E335**

ACCESSORIO  
TETTO ANTIPOLVERE  
art. **E395**



ART.	DIMENSIONI LxPxH (mm)	VANI
<b>E334</b>	360 x 330 x 1800	1
<b>E335</b>	690 x 330 x 1800	2
<b>E336</b>	1020 x 330 x 1800	3

ELENCO ACCESSORI

Gruccia pag. 13  
Lucchetto pag. 13  
Serratura pag. 13

NOTE TECNICHE

• **STRUTTURA MONOBLOCCO.**  
• **VERNICIATURA A POLVERE.**

COLORE DI SERIE

  
RAL 7038

VARIANTE COLORE

  
RAL 7038 scocche  
RAL 5015 ante  
CONSEGNA 30 GG.



**PROFONDITÀ 500 mm.**

Vano cappelliera mm. 270 x 390 x 165 h. utile.



ARMADIO  
art. **E341**

ACCESSORIO  
TETTO  
ANTIPOLVERE  
art. **E397**



ARMADIO  
art. **E342**

ACCESSORIO  
TETTO  
ANTIPOLVERE  
art. **E398**



ARMADIO  
art. **E343**

ACCESSORIO  
TETTO  
ANTIPOLVERE  
art. **E399**



**PROFONDITÀ 500 mm.**

Vano cappelliera mm. 425 x 390 x 165 h. utile.



ARMADIO  
art. **E345**

ACCESSORIO  
TETTO ANTIPOLVERE  
art. **E401**



ARMADIO  
art. **E346**

ACCESSORIO  
TETTO ANTIPOLVERE  
art. **E402**



**PROFONDITÀ 500 mm.**

Vano cappelliera mm. 425 x 390 x 165 h. utile.  
Con tramezza zincata.



ARMADIO  
art. **E348**

ACCESSORIO  
TETTO ANTIPOLVERE  
art. **E401**



ARMADIO  
art. **E337**

ACCESSORIO  
TETTO ANTIPOLVERE  
art. **E402**

ART.	DIMENSIONI LxPxH (mm)	VANI
<b>E341</b>	360 x 500 x 1800	1
<b>E342</b>	690 x 500 x 1800	2
<b>E343</b>	1020 x 500 x 1800	3
<b>E345</b>	515 x 500 x 1800	1
<b>E346</b>	1000 x 500 x 1800	2
<b>E348</b>	515 x 500 x 1800	1+1
<b>E337</b>	1000 x 500 x 1800	2+2



TETTO ANTIPOLVERE  
vedi pag. 13

ELENCO  
ACCESSORI

Grucce pag. 13  
Lucchetto pag. 13  
Serratura pag. 13

NOTE  
TECNICHE

• **STRUTTURA MONOBLOCCO.**  
• **VERNICIATURA A POLVERE.**

COLORE  
DI SERIE

  
RAL 7038

VARIANTE  
COLORE

  
RAL 7038 scocche  
RAL 5015 ante  
CONSEGNA 30 GG.



**PROFONDITÀ 500 mm.**

Vano cappelliera mm. 345 x 390 x 165 h. utile.  
Con tramezza zincata.



ARMADIO  
art. **E331**

ACCESSORIO  
TETTO  
ANTIPOLVERE  
art. **E385**



ARMADIO  
art. **E332**

ACCESSORIO  
TETTO  
ANTIPOLVERE  
art. **E386**



ARMADIO  
art. **E333**

ACCESSORIO  
TETTO  
ANTIPOLVERE  
art. **E387**



**PROFONDITÀ 500 mm.**

Vano interno mm. 330 x 475 x 745 h. utile.



ARMADIO  
art. **E388**

ACCESSORIO  
TETTO  
ANTIPOLVERE  
art. **E397**



ARMADIO  
art. **E390**

ACCESSORIO  
TETTO  
ANTIPOLVERE  
art. **E398**



ARMADIO  
art. **E392**

ACCESSORIO  
TETTO  
ANTIPOLVERE  
art. **E399**

ART.	DIMENSIONI LxPxH (mm)	VANI
<b>E331</b>	415 x 500 x 1800	1 + 1
<b>E332</b>	810 x 500 x 1800	2 + 2
<b>E333</b>	1200 x 500 x 1800	3 + 3
<b>E388</b>	360 x 500 x 1800	2
<b>E390</b>	690 x 500 x 1800	4
<b>E392</b>	1020 x 500 x 1800	6



TETTO ANTIPOLVERE  
vedi pag. 13

**SPAZI COMUNI**

ARMADI SPOGLIATOIO CON PANCA E VANO PORTASCARPE

**ELENCO ACCESSORI**

Gruccia pag. 13  
 Lucchetto pag. 13  
 Serratura pag. 13

**NOTE TECNICHE**

- ARMADIO MONOBLOCCO.
- PANCA SMONTATA.
- VERNICIATURA A POLVERE.
- TRAMEZZA ZINCATA.

**COLORE DI SERIE**

RAL 7038



NOCE BAHIA

**SERIE | CLASSICO**

Realizzati in lamiera di acciaio di prima scelta spessore mm. 6-7/10. Ogni posto è corredato di 1 cappelliera, 1 portagruccie, 2 ganci per asciugamani e 1 anello con vaschetta portaombrelli. Le ante sono rinforzate, dotate di feritoie di aerazione, portacartellino e chiusura con nasello in plastica lucchettabile. **Le panche**, realizzate in acciaio con seduta a 4 doghe in legno di noce bahia, hanno dimensioni di mm. 1000 x 320 x 490 h. e possono essere dotate di 2 vani portascarpe con serratura inseriti ad incastro. **Spazio utile del vano portascarpe: mm. 335 x 300 x 240 h.**



art. E415



art. E416



art. E417



art. E421



art. E422



art. E423

ART.	DESCRIZIONE	DIM. INGOMBRO LxPxH (mm)	DIM.SPOGLIATOIO LxPxH (mm)
E415	2 vani di mm. 500 x 500 con tramezza	1000 x 820 x 2065	1000 x 500 x 1600
E416	2 vani di mm. 500 x 500 senza tramezza	1000 x 820 x 2065	1000 x 500 x 1600
E417	3 vani di mm. 330 x 500 senza tramezza	1020 x 820 x 2065	1020 x 500 x 1600
E421	2 vani di mm. 500 x 500 con tramezza	1000 x 820 x 2065	1000 x 500 x 1600
E422	2 vani di mm. 500 x 500 senza tramezza	1000 x 820 x 2065	1000 x 500 x 1600
E423	3 vani di mm. 330 x 500 senza tramezza	1020 x 820 x 2065	1020 x 500 x 1600



TETTO ANTIPOLVERE  
 vedi pag. 13

ELENCO  
ACCESSORI

Grucce pag. 13  
Nasello in metallo pag. 13

NOTE  
TECNICHE

• **STRUTTURA MONOBLOCCO.**  
• **VERNICIATURA A POLVERE.**

COLORE  
DI SERIE

 **RAL 7038**  
scocche

 **RAL 5015**  
ante

Realizzati in lamiera di acciaio di prima scelta, spessore 6-7/10. Zoccolo di mm. 90 h. e vano interno di mm. 1680 h. utile. Ogni posto è corredato di portagruccie, anello e vaschetta portaombrelli, cappelliera e 2 ganci per asciugamani. Le ante sono rinforzate, dotate di feritoie di aerazione, portacartellino e chiusura con serratura a linguetta.



**PROFONDITÀ 500 mm.**

Vano cappelliera mm. 255 x 390 x 190 h. utile.



ARMADIO  
art. **E314GB**

ACCESSORIO  
TETTO  
ANTIPOLVERE  
art. **E420**



ARMADIO  
art. **E312GB**

ACCESSORIO  
TETTO  
ANTIPOLVERE  
art. **E419**



ARMADIO  
art. **E316GB**

ACCESSORIO  
TETTO  
ANTIPOLVERE  
art. **E387**

ART.	DIMENSIONI LxPxH (mm)	VANI
<b>E312GB</b>	610 x 500 x 1800	2
<b>E314GB</b>	905 x 500 x 1800	3
<b>E316GB</b>	1200 x 500 x 1800	4



TETTO ANTIPOLVERE  
vedi pag. 13



CODICE | SP3633  
DIM. CM. L X P X H 36 X 33 X 180  
KG 16,75  
0,195 M3  
EAN 8032615400199

ARMADI SPOGLIATOI 1 PORTA



CODICE | SP3633/SCARPE  
DIM. CM. L X P X H 36 X 33 X 180  
KG 16,80  
0,214 M3  
EAN 8032615403688

ARMADI SPOGLIATOI 1 PORTA PORTASCARPE



CODICE | SPP3633/SCARPE  
DIM. CM. L X P X H 36 X 33 X 180  
KG 19,10  
0,214 M3  
EAN 8032615402056

ARMADI SPOGLIATOI SPORCO PULITO 1 PORTA PORTASCARPE

CODICE | SPP044/SCARPE  
DIM. CM. L X P X H 40 X 38 X 180  
KG 22,65  
0,288 M3  
EAN 8032615404319

CODICE | SPP054/SCARPE  
DIM. CM. L X P X H 50 X 38 X 180  
KG 25,40  
0,360 M3  
EAN 8032615404326



CODICE | SP3650  
DIM. CM. L X P X H 36 X 50 X 180  
KG 19  
0,330 M3  
EAN 8032615401721

CODICE | SP4050  
DIM. CM. L X P X H 40 X 50 X 180  
KG 21,50  
0,360 M3  
EAN 8032615403640

CODICE | SP5050  
DIM. CM. L X P X H 50 X 50 X 180  
KG 23  
0,450 M3  
EAN 8032615403657

ARMADI SPOGLIATOI 1 PORTA



CODICE | SP3650/SCARPE  
DIM. CM. L X P X H 36 X 50 X 180  
KG 19  
0,324 M3  
EAN 8032615403695

CODICE | SP4050/SCARPE  
DIM. CM. L X P X H 40 X 50 X 180  
KG 21,50  
0,360 M3  
EAN 8032615403701

CODICE | SP5050/SCARPE  
DIM. CM. L X P X H 50 X 50 X 180  
KG 23  
0,450 M3  
EAN 8032615403718

ARMADI SPOGLIATOI 1 PORTA PORTA SCARPE



CODICE | SPP3650/SCARPE  
DIM. CM. L X P X H 36 X 50 X 180  
KG 23  
0,324 M3  
EAN 8032615402704

CODICE | SPP056/SCARPE  
DIM. CM. L X P X H 40 X 50 X 180  
KG 24,55  
0,360 M3  
EAN 8032615404357

CODICE | SPP055/SCARPE  
DIM. CM. L X P X H 50 X 50 X 180  
KG 27,60  
0,450 M3  
EAN 8032615404364

ARMADI SPOGLIATOIO 1 PORTA SPORCO PULITO PORTASCARPE



CODICE | SP6P33  
DIM. CM. L X P X H 69 X 33 X 180  
KG 26,75  
0,410 M3  
EAN 80326154.00205

ARMADI SPOGLIATOIO | 2 PORTE

ARMADI SPOGLIATOIO | 2 PORTE  
PORTASCARPE

CODICE | SP6933/SCARPE  
DIM. CM. L X P X H 69 X 33 X 180  
KG 27,50  
0,410 M3  
EAN 80326154.03725



CODICE | SPP6933/SCARPE  
DIM. CM. L X P X H 69 X 33 X 180  
KG 31,40  
0,410 M3  
EAN 80326154.02278

CODICE | SPP084/SCARPE  
DIM. CM. L X P X H 77 X 38 X 180  
KG 35  
0,576 M3  
EAN 80326154.04333

CODICE | SPP104/SCARPE  
DIM. CM. L X P X H 97 X 38 X 180  
KG 41  
0,713 M3  
EAN 80326154.04340

ARMADI SPOGLIATOIO SPORCO PULITO  
2 PORTE PORTASCARPE

ARMADI SPOGLIATOIO  
I 2 PORTE PORTASCARPE



CODICE | SP6P50  
DIM. CM. L X P X H 69 X 50 X 180  
KG 32  
0,621 M3  
EAN 8032615401738

CODICE | SP8050  
DIM. CM. L X P X H 77 X 50 X 180  
KG 34  
0,720 M3  
EAN 8032615403749

CODICE | SP9950  
DIM. CM. L X P X H 97 X 50 X 180  
KG 36  
0,891 M3  
EAN 8032615403671



CODICE | SP6950/SCARPE  
DIM. CM. L X P X H 69 X 50 X 180  
KG 32  
0,621 M3  
EAN 8032615403732

CODICE | SP8050/SCARPE  
DIM. CM. L X P X H 77 X 50 X 180  
KG 35  
0,720 M3  
EAN 8032615403749

CODICE | SP9950/SCARPE  
DIM. CM. L X P X H 97 X 50 X 180  
KG 37  
0,891 M3  
EAN 8032615403756

CODICE | SPP6950/SCARPE  
DIM. CM. L X P X H 69 X 50 X 180  
KG 33,89  
0,621 M3  
EAN 8032615403626

CODICE | SPP085/SCARPE  
DIM. CM. L X P X H 77 X 50 X 180  
KG 37  
0,720 M3  
EAN 8032615401639

CODICE | SPP105/SCARPE  
DIM. CM. L X P X H 97 X 50 X 180  
KG 41  
0,890 M3  
EAN 8032615401646



ARMADI SPOGLIATOIO SPORCO PULITO  
2 PORTE PORTASCARPE

ARMADI SPOGLIATOIO I 2 PORTE

ARMADI SPOGLIATOIO | 3 PORTE

CODICE | SP10133  
DIM. CM. L X P X H 101 X 33 X 180  
KG 38,65  
0,600 M3  
EAN 8032615400212



ARMADI SPOGLIATOIO PORTASCARPE | 3 PORTE

CODICE | SP10133/SCARPE  
DIM. CM. L X P X H 101 X 33 X 180  
KG 40  
0,600 M3  
EAN 8032615403763



ARMADI SPOGLIATOIO SPORCO PULITO  
| 3 PORTE PORTASCARPE

CODICE | SPP10133/SCARPE  
DIM. CM. L X P X H 101 X 33 X 180  
KG 42  
0,600 M3  
EAN 8032615402285



### ARMADI SPOGLIATOIO | 3 PORTE

CODICE | SP10150  
DIM. CM. L X P X H 101 X 50 X 180  
KG 43  
0,910 M3  
EAN 8032615401745



### ARMADI SPOGLIATOIO | 3 PORTE PORTASCARPE

CODICE | SP10150/SCARPE  
DIM. CM. L X P X H 101 X 50 X 180  
KG 44  
0,910 M3  
EAN 8032615403770



### ARMADI SPOGLIATOIO SPORCO PULITO | 3 PORTE PORTASCARPE

CODICE | SPP10150/SCARPE  
DIM. CM. L X P X H 101 X 50 X 180  
KG 48,81  
0,910 M3  
EAN 8032615403633

